

12

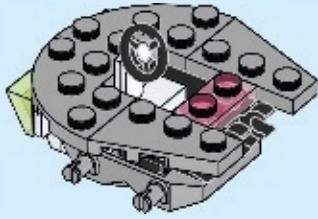

13

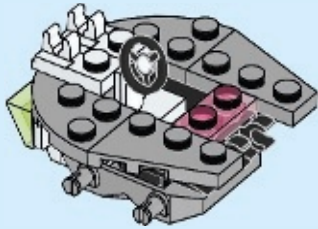

14

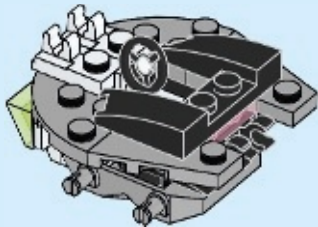

15

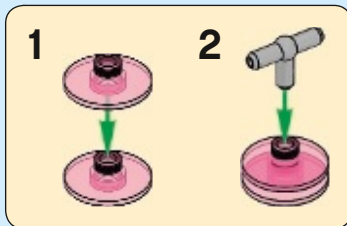

16

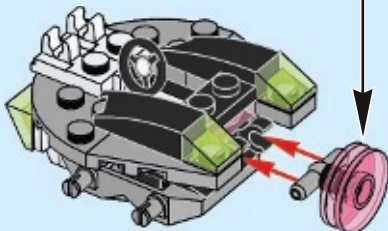

17

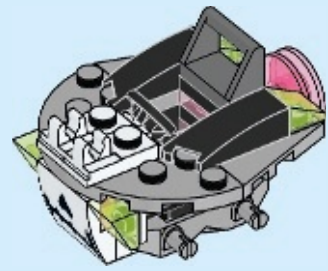

18

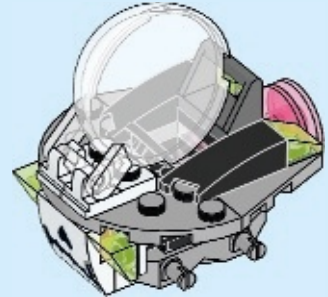

19

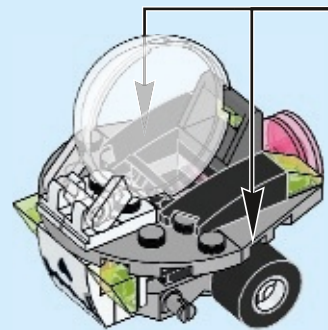

20

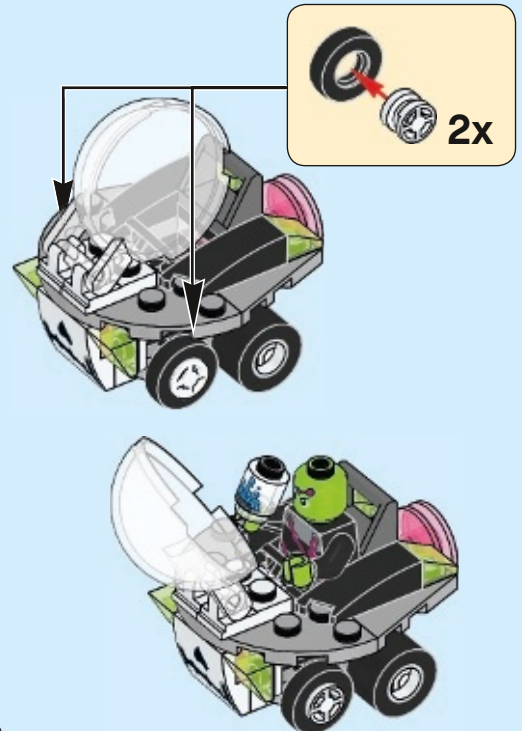

[LEGO.com/service](http://LEGO.com/service)

LEGO and the LEGO logo are trademarks of the LEGO Group. ©2018 The LEGO Group. 6222226

All DC characters and elements © & ™ DC Comics.

WB SHIELD: TM & © WBEI. (s18)